



# HIGHLY FLEXIBLE COUPLINGS ELPEX-S

# HIGHLY FLEXIBLE COUPLINGS – ELPEX-S SERIES



<b>General</b>	<b>11/3</b>
Benefits	11/3
Application	11/3
Design and configurations	11/4
Function	11/6
Configuration	11/6
Technical specifications	11/8
-----	
<b>Type ESN</b>	<b>11/14</b>
-----	
<b>Type ESNR</b>	<b>11/16</b>
-----	
<b>Type ESD</b>	<b>11/18</b>
-----	
<b>Type ESDR</b>	<b>11/19</b>
-----	
<b>Type ESNW</b>	<b>11/20</b>
-----	
<b>Type ESDW</b>	<b>11/21</b>
-----	
<b>Type EST</b>	<b>11/22</b>
-----	
<b>Spare and wear parts</b>	<b>11/23</b>
-----	



ELPEX-S  
**FLENDER**



# GENERAL



**Coupling suitable for use in potentially explosive atmospheres.**

**Complies with the current ATEX Directive for:**

CE  II 2G Ex h IIC T4 ... T3 Gb X

 II 2D Ex h IIIC T120 °C ... 160 °C Db X

 I M2 Ex h Mb X

(Type EST is not available in Ex version.)

ELPEX-S couplings are highly torsionally flexible and because of their low torsional stiffness and damping capacity are especially suitable for coupling machines with a highly non uniform torque pattern.

Standard ELPEX-S coupling types are designed as flange-shaft-connections or shaft-shaft connections.

Application-related types can be implemented on request.

## Benefits

The ELPEX-S coupling is suitable for horizontal and vertical mounting positions or mounting at any required angle. The coupling parts can be arranged as required on the shafts to be connected.

ELPEX-S couplings are especially suitable for reversing operation or operation with changing directions of load.

The rubber disk elements are fitted virtually without backlash and give the coupling linear torsional stiffness, i.e. the torsion stiffness remains constant even when the load on the coupling increases.

There are 4 different rubber element versions with different grades of torsional stiffness available for each size from stock.

## Application

The ELPEX-S coupling is available as a catalog standard in 12 sizes with rated torques of between 330 Nm and 63000 Nm.

The coupling is suitable for ambient temperatures of between -40 °C and +120 °C.

The ELPEX-S coupling is frequently used for diesel motor drives or reciprocating compressor drives.

On certain types the flexible rings can be changed without having to move the coupled machines.

If substantial overload occurs, the rubber disk element of the coupling is irreparably damaged, the coupling throws the load and thus limits the overload for particular operating conditions. The coupling can be inserted and fitted blind e.g. in a bell housing.

There are outer flanges with different connection dimensions available for each coupling size.

Because the different rubber versions enable the torsional stiffness to be adjusted to meet requirements, the coupling is also suitable for drives which require a specific and preferably precalculated torsional vibration behavior setting.

# GENERAL

## Design and configurations

The rubber disk element is vulcanized onto a flange on the inside diameter. The flange can mount e.g. a Taper clamping bush or a hub. On its outer diameter the rubber disk element has driving teeth, which are inserted into the outer flange. The torque is transmitted positively between the rubber disk element and the outer flange.

In the type for shaft-shaft connection the outer flange is screwed to a flange hub mounted on a machine shaft.

### Materials

	Type EST	Types ESN. and ESD.
Rubber disk element	EN-GJL-250 grey cast iron/ elastomer	EN-GJL-400 spheroidal graphite cast iron/elastomer
Hubs, part 1, part 2	Steel	Steel
Outer flange	Cast aluminum Zn10Si8Mg Sizes 680 and 770 of spheroidal graphite cast iron EN-GJS-500	Cast aluminum Zn10Si8Mg Sizes 680 and 770 of spheroidal graphite cast iron EN-GJS-500

### Elastomer materials of the rubber disk element

Material/ description	Hardness ShoreA	Marking	Ambient temperature
Natural-synthetic rubber mixture	50 ° ... 55 °	WN	-40 °C ... +80 °C
	60 ° ... 65 °	NN	-40 °C ... +80 °C
	70 ° ... 75 °	SN	-40 °C ... +80 °C
Silicone rubber	55 ° ... 65 °	NX	-40 °C ... +120 °C

11

### ELPEX-S coupling types

Type	Description
<b>ESN</b>	Coupling with hub, long or short version
<b>ESD</b>	Coupling with hub, with two rubber disk elements
<b>ESNR</b>	Coupling with hub, rubber disk element radially dismountable
<b>ESDR</b>	Coupling with hub with two rubber disk elements; rubber disk elements radially dismountable
<b>ESNW</b>	Coupling designed as a shaft-shaft connection with a rubber disk element; rubber disk element radially dismountable
<b>ESDW</b>	Coupling designed as a shaft-shaft connection with two rubber disk elements; rubber disk element radially dismountable
<b>EST</b>	Coupling suitable for mounting a Taper clamping bush

Further application-related coupling types are available. Dimension sheets for and information on these are available on request.

The following versions have already been implemented a number of times:

- ELPEX-S coupling with brake drum, brake disk or flywheel mass
- ELPEX-S coupling with axial backlash limiter
- ELPEX-S coupling with adapter
- ELPEX-S coupling with bearing for mounting a cardan shaft
- ELPEX-S coupling for engaging/disengaging during standstill
- ELPEX-S coupling as part of a coupling combination
- ELPEX-S coupling with fail-safe device

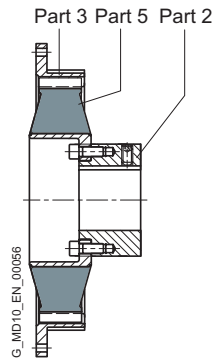

Type ESN – long version

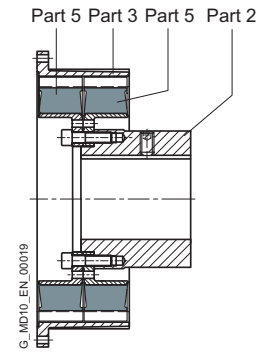

Type ESD

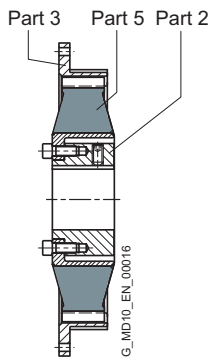

Type ESN – short version

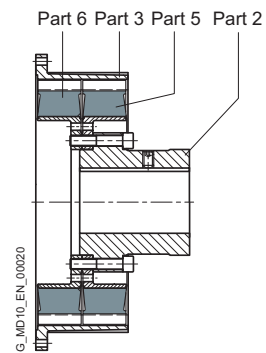

Type ESDR

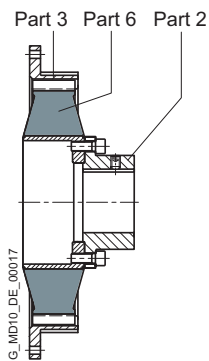

Type ESNR

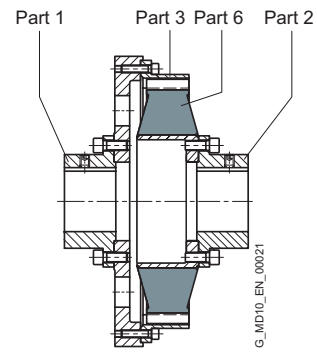

Type ESNW

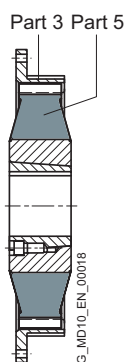

Type EST

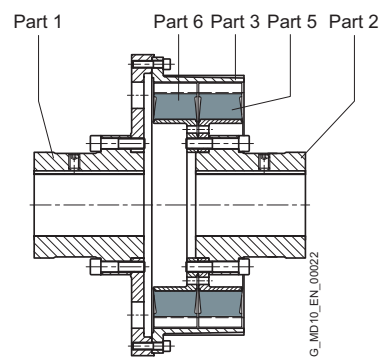

Type ESDW

# GENERAL

## Fail-safe device of ELPEX-S coupling

The ELPEX-S coupling can also be designed with a fail-safe device. If the rubber disk element fails, the coupling can continue operating in emergency mode for a short time. This option is frequently required e.g. in the case of marine drives.

If the rubber disk element fails, cams transmit the torque from the inner and outer parts of the fail-safe device.

In normal operation the torsion angle of the rubber disk element is smaller than the gap between the cams, so there is no metal-metal contact.

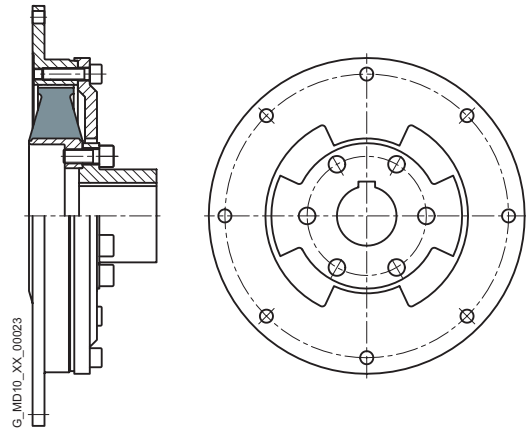

## Function

The ELPEX-S coupling's transmission characteristic is determined essentially by the rubber disk element. The torque is transmitted positively between the rubber disk element and the outer flange.

The outer flange can be bolted to e.g. a diesel motor or compressor flywheel.

11

## Configuration

### Coupling selection

The ELPEX-S coupling is especially suitable for rough operating environments. An application factor lower than that in the **chapter introduction** is therefore sufficient for all applications.

In the case of machines which excite torsional vibration, Flender urgently recommends carrying out a torsional vibration calculation or measuring the coupling load occurring in the drive.

### Coupling load in continuous operation

Application factor FB	Torque characteristic of the driven machine		
	uniform with moderate shock loads	non uniform	very rough
Electric motors, hydraulic motors, gas and water turbines	1.0	1.3	1.4
Internal-combustion engines	1.3	1.4	1.6

### Examples of torque characteristic in driven machines:

- uniform with moderate shock loads: Generators, fans, blowers
- non uniform: Reciprocating compressors, mixers, conveyor systems
- very rough: crushers, excavators, presses, mills

Temperature factor FT		Temperature $T_a$ on the coupling									
Coupling	Rubber version	Elastomer material	-40 up to -30 °C	-30 up to +50 °C	up to 60 °C	up to 70 °C	up to 80 °C	up to 90 °C	up to 100 °C	up to 110 °C	up to 120 °C
ELPEX-S	SN, NN, WN	NR	1.1	1.0	1.25	1.40	1.60	-	-	-	-
	NX	VMQ	1.1	1.0	1.0	1.0	1.0	1.1	1.25	1.4	1.6

NR = Natural-synthetic rubber mixture  
 VMQ = Silicone rubber

$$\text{Coupling size } T_{KN} \geq T_N \cdot FB \cdot FT$$

### Coupling load under maximum and overload conditions

The maximum torque is the highest load acting on the coupling in normal operation.

Maximum torques at a frequency of up to 25 times an hour are permitted and must be lower than the maximum coupling torque. Examples of maximum torque conditions are: Starting operations, stopping operations or usual operating conditions with maximum load.

$$T_{K_{\max}} \geq T_{\max} \cdot FT$$

Overload torques are maximum loads which occur only in combination with special, infrequent operating conditions. Examples of overload torque conditions are: Motor short circuit, emergency stop or blocking because of component breakage. Overload torques at a frequency of once a month are permitted and must be lower than the maximum overload torque of the coupling. The overload condition may last only a short while, i.e. fractions of a second.

$$T_{K_{OL}} \geq T_{OL} \cdot FT$$

### Coupling load due to dynamic torque load

Applying the frequency factor FF, the dynamic torque load must be lower than the coupling fatigue torque.

Dynamic torque load





$$T_{KW} \geq T_W \cdot FF \cdot FF$$

Frequency of the dynamic torque load

$$f_{err} \leq 10 \text{ Hz frequency factor } FF = 1.0$$

Frequency of the dynamic torque load

$$f_{err} > 10 \text{ Hz frequency factor } FF = \sqrt{(f_{err}/10 \text{ Hz})}$$

-  Operation in potentially explosive environments is subject to the following restriction:  
Operation with low fatigue load
-  The fatigue torque  $T_{KW}$  must be reduced by 70 %. In these particular operating conditions the coupling satisfies the requirements of temperature class T4 D120 °C.  
Operation with medium fatigue load
-  The fatigue torque  $T_{KW}$  must be reduced by 50 %. In these particular operating conditions the coupling satisfies the requirements of temperature class T3 D160 °C.
-  Type EST is not permitted for application in potentially explosive environments.

### Checking the maximum speed

The following must apply to all load situations:  $n_{K_{\max}} \geq n_{\max}$   
The maximum speed of a size depends only on the size of the outer flange (part 3).

### Checking permitted shaft misalignment and restorative forces

For all load situations, the actual shaft misalignment must be less than the permitted shaft misalignment.

### Checking bore diameter, mounting geometry and coupling design

The check must be made on the basis of the dimension tables.

On request, couplings with adapted geometry can be provided.

### Checking shaft-hub connection

For any information on this, please refer to [Page E/20](#).

### Checking temperature and chemically aggressive environment

The permitted coupling temperature is specified in the Temperature Factor FT table. In the case of chemically aggressive environments, please consult the manufacturer.



# GENERAL

## Technical specifications

Performance data for rubber disk elements made of a mix of natural and synthetic rubber

Type	Size	Rubber version	Rated torque	Maximum torque	Overload torque	Fatigue torque	dynamic torsional stiffness	Motor flange SAE J620d Size	Maximum speed $n_{max}$ rpm
			$T_{KN}$ Nm	$T_{Kmax}$ Nm	$T_{KOL}$ Nm	$T_{KW}$ Nm	$C_{Tdyn}$ Nm/rad		
ESN . EST	220	WN	330	660	750	165	1600	6.5	4200
		NN	360	720	900	180	2500	7.5	4200
		SN	400	800	1000	200	4200	8 10	4200 3600
ESN . EST	265	WN	500	1000	1250	250	2400	8	4200
		NN	600	1200	1800	300	3600	10	3600
		SN	700	1400	2100	350	6100	11.5	3500
ESN . EST	290	WN	800	1600	2000	400	3600	10	3600
		NN	900	1800	2700	450	5000	11.5	3500
		SN	1000	2000	3000	500	7500		
ESN . EST	320	WN	1200	2400	3000	600	8000	11.5	3500
		NN	1350	2700	3600	650	10000	14	3000
		SN	1550	3100	4200	750	13500		
ESN . EST	360	WN	1800	3600	4500	900	8500	11.5	3200
		NN	2000	4000	5400	1000	13000	14	3000
		SN	2500	5000	7500	1250	22000		
ESN . EST	420	WN	3100	6200	7700	1500	16000	14	3000
		NN	3450	6900	10000	1700	30000	16	2600
		SN	4200	8400	12600	2100	45000	18	2300
ESN . EST	465	WN	4600	9200	10000	2300	35000	14	3000
		NN	5200	10400	15600	2600	56000	16	2600
		SN	6300	12600	18900	3100	100000	18	2300
ESN .	520	WN	6200	12400	14000	3100	38000	18	2300
		NN	7000	14000	21000	3500	75000	21	2000
		SN	7800	15600	23400	3900	110000		
ESD .	520	WN	12400	24800	28000	6200	76000	18	2300
		NN	14000	28000	42000	7000	150000	21	2000
		SN	15600	31200	46800	7800	220000		
ESN .	560	WN	8000	16000	18000	4200	55000	18	2300
		NN	9000	18000	27000	4800	100000	21	2000
		SN	10000	20000	30000	5500	190000		
ESD .	560	WN	16000	32000	36000	8400	110000	18	2300
		NN	18000	36000	54000	9600	200000	21	2000
		SN	20000	40000	60000	11000	380000		

Performance data for rubber disk elements made of a mix of natural and synthetic rubber									
Type	Size	Rubber version	Rated torque	Maximum torque	Overload torque	Fatigue torque	dynamic torsional stiffness	Motor flange SAE J620d Size	Maximum speed max rpm
			$T_{KN}$ Nm	$T_{Kmax}$ Nm	$T_{KOL}$ Nm	$T_{KW}$ Nm	$C_{Tdyn}$ Nm/rad		
ESN .	580	WN	11000	22000	28000	5500	75000	18	2300
		NN	12500	25000	37000	6250	120000		
		SN	14000	28000	42000	7000	210000	21	2000
ESD .	580	WN	22000	44000	56000	11000	150000		
		NN	25000	50000	74000	12500	240000		
		SN	28000	56000	84000	14000	420000	24	1800
ESN .	680	WN	16000	32000	40000	8000	150000		
		NN	18000	36000	54000	9000	250000		
		SN	20000	40000	60000	10000	450000	24	1800
ESD .	680	WN	32000	64000	80000	16000	300000		
		NN	36000	72000	108000	18000	500000		
		SN	40000	80000	120000	20000	900000	24	1800
ESN .	770	WN	25000	50000	75000	12500	250000		
		NN	28000	56000	84000	14000	400000		
		SN	31500	63000	94000	15000	700000		
ESD .	770	WN	50000	100000	150000	25000	500000	similar to DIN 6288	1300
		NN	56000	112000	168000	28000	800000		
		SN	63000	126000	189000	30000	1400000		

**Torsional stiffness and damping**

Torsional stiffness depends on the ambient temperature and the frequency and amplitude of the torsional vibration excitation. More precise torsional stiffness and damping parameters on request.

With flexible couplings the manufacturing process of the rubber elements and their aging primarily influence the stiffness value  $C_{Tdyn}$ .

For this reason calculation must be made with a tolerance for the dynamic stiffness of  $\pm 20\%$ . The specified damping coefficient  $\Psi$  is a minimum value with the result that the damping performance of the coupling corresponds at least to the specified value.

# GENERAL

## Technical specifications

Power ratings of the rubber disk elements made of silicone rubber											
Type	Size	Rubber version	Rated torque		Maximum torque		Overload torque		Fatigue torque		Dynamic torsional stiffness for 100 % load $C_{Tdyn}$ kNm/rad
			$T_{KN}$ Nm		$T_{Kmax}$ Nm		$T_{KOL}$ Nm		$T_{KW}(10\text{ Hz})$ Nm		
ESN .	220	NX	200		300		400		87		1.3
ESN .	265	NX	300		450		600		133		2.4
ESN .	290	NX	500		750		1000		213		4.2
ESN .	320	NX	770		1150		1530		320		9.2
ESN .	360	NX	1200		1800		2400		480		10
ESN .	420	NX	2000		3000		4000		800		23
ESN .	465	NX	3000		4500		6000		1200		60
ESN .	520	NX	4100		6100		8200		1600		65
ESD .	520	NX	8200		12300		16400		3200		130
ESN .	560	NX	5000		7500		10000		2200		100
ESD .	560	NX	10000		15000		20000		4400		200
ESN .	580	NX	6500		9750		13000		2667		160
ESD .	580	NX	13000		19500		26000		5867		310
ESN .	680	NX	10000		15000		20000		4000		280
ESD .	680	NX	20000		30000		40000		8000		550
ESN .	770	NX	15000		22500		30000		6000		620
ESD .	770	NX	30000		45000		60000		12000		1230

11

### Torsional stiffness

The dynamic torsional stiffness of the silicone rubber elements is load-dependent and increases in proportion to the load. The values specified in the selection table represent 100 % loading. The following table shows the correction factors for different rated loads.

$$C_{Tdyn} = C_{Tdyn\ 100\ \%} \cdot FK C$$

Correction factor FK C	Load $T_N / T_{KN}$						
	20%	50%	60%	70%	80%	100%	150%
	0.59	0.75	0.79	0.83	0.88	1	1.5

Torsional stiffness also depends on the ambient temperature and the frequency and amplitude of the torsional vibration excitation. More precise torsional stiffness and damping parameters on request.

Damping coefficient

Damping coefficient of the rubber versions		
Rubber version	Hardness ShoreA	Damping coefficient $\Psi$
WN	55 ° ± 5 °	0.80
NN	65 ° ± 5 °	1.15
SN	75 ° ± 5 °	1.25
NX	60 ° ± 5 °	1.15

With flexible couplings the manufacturing process of the rubber elements and their aging primarily influence the stiffness value  $C_{Tdyn}$ . For this reason calculation must be made with a tolerance for the dynamic stiffness of ± 20 %. The specified damping coefficient  $\Psi$  is a minimum value with the result that the damping performance of the coupling corresponds at least to the specified value.

Permitted shaft misalignment

The permitted shaft misalignment depends on the operating speed. As the speed increases, lower shaft misalignment values are permitted.

For fitting, the maximum gap dimension of  $S_{max.} = S + \Delta S$  and the minimum gap dimension of  $S_{min.} = S - \Delta S$  are permitted.

Size	Assembly Shaft distance $\Delta S$ mm	Permitted shaft misalignment at $n = 1500$ rpm		
		Axial $\Delta K_a$ mm	Radial $\Delta K_r$ mm	Angle $\Delta K_w$ degree
220	1.3	0.2	1.2	0.5
265	1.3	0.2	1.2	0.5
290	1.5	0.2	1.2	0.5
320	1.5	0.2	1.2	0.5
360	1.5	0.2	1.2	0.5
420	1.5	0.3	1.3	0.4
465	1.7	0.3	1.3	0.4
520	1.7	0.3	1.4	0.4
560	1.7	0.3	1.4	0.4
580	1.8	0.4	1.5	0.3
680	1.8	0.4	1.5	0.3
770	2.0	0.5	1.5	0.3

The correction factors for different speeds are specified in the following table.

The maximum speed for the respective coupling size and type must be noted!

$$\Delta K_{perm} = \Delta K_{1500} \cdot FKV$$

	Speed in rpm			
	500	1000	1500	3000
Correction factor FKV	1.2	1.1	1.0	0.7

# GENERAL

## Variants of the outer flange

The outer flange of sizes 220 to 680 is designed to fit the connection dimensions of the SAE J620d standard. The centering depth on the connection flange of the machine should be between 4 mm and 6.4 mm maximum.

Type	Size	Flange connection size	Figure
ESN	220	6.5	1
ESN, ESNR	220	7.5	2
	265	8	
	360	11.5	
	465	14	
	580	18	
	680	21	
ESN, ESNR	220	8, 10	3
	265	10, 11.5	
	290	all	
	320	all	
	360	14	
	420	all	
	465	16, 18	
	520	all	
	560	all	
	580	21	
680	24		
ESNR	770	all	
ESD, ESDR	520	all	4
	560	all	
	580	all	
ESD, ESDR	680	21	5
ESD, ESDR	680	24	6
ESDR	770	all	

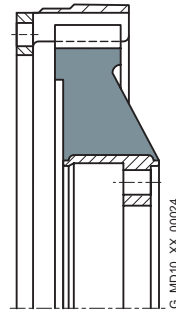

Figure 1

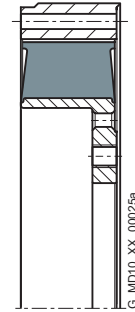

Figure 2

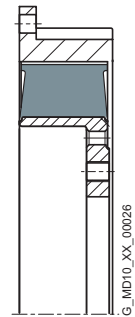

Figure 3

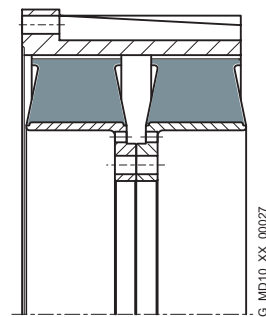

Figure 4

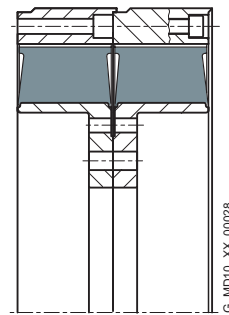

Figure 5

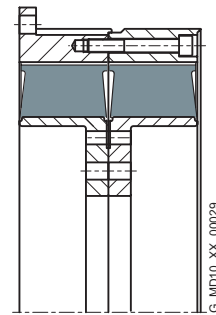
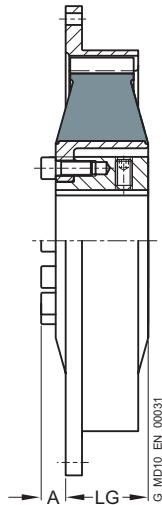

Figure 6



# TYPE ESN



Short version

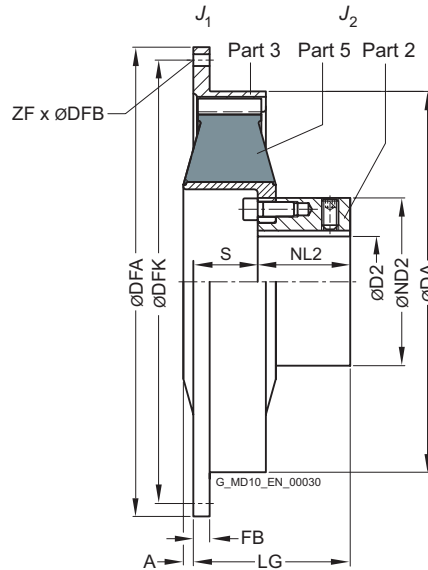

Long version

11

Size	Dimensions in mm											Mass moment of inertia		Article no. <sup>1)</sup>		Weight m kg				
	D2 Keyway DIN 6885 max.	DA	ND2	NL2	short version		long version			Flange connection dimensions					J <sub>1</sub> kgm <sup>2</sup>		J <sub>2</sub> kgm <sup>2</sup>	Type	short version	long version
					A	LG	A	S	LG	SAE size	DFA	DFK	FB	ZF						
220	60	222	98	54	-	-	0	49	103	6.5	215.9	200.0	6	6	8.5	0.008	0.01	-	2LC0220-0AB0	5.8
		237						40	94	7.5	241.3	222.3	33	8	8.5	0.011		-	2LC0220-0AB0	6.1
		222						40	94	8	263.5	244.5	8	6	10.5	0.011		-	2LC0220-0AB0	6.4
		222						40	94	10	314.3	295.3	8	8	10.5	0.017		-	2LC0220-0AB0	6.9
265	65	263	118	65	15	74	3	39	104	8	263.5	244.5	33	6	0.011	0.022	2LC0220-1AA0	2LC0220-1AB0	6.6	
										10	314.3	295.3	10	8	10.5		0.017	2LC0220-1AA0	2LC0220-1AB0	6.9
										11.5	352.4	333.4	10	8	0.024		2LC0220-1AA0	2LC0220-1AB0	7.2	
290	65	290	118	70	18	58	6	36	106	10	314.3	295.3	16	8	0.026	0.026	2LC0220-2AA0	2LC0220-2AB0	9.2	
										11.5	352.4	333.4	16	8	0.036		2LC0220-2AA0	2LC0220-2AB0	10.5	
320	80	318	140	87	15	96	2	70	157	11.5	352.4	333.4	16	8	10.5	0.062	0.061	2LC0220-3AA0	2LC0220-3AB0	19
										14	466.7	438.2	16	8	13	0.18		2LC0220-3AA0	2LC0220-3AB0	20.5
360	90	353.5	160	105	29	92	13	56	161	11.5	352.4	333.4	54	8	10.5	0.065	0.13	2LC0220-4AA0	2LC0220-4AB0	24.5
										14	466.7	438.2	15	8	13	0.18		2LC0220-4AA0	2LC0220-4AB0	27.5
										14	466.7	438.2	18	8	13	0.22		2LC0220-5AA0	2LC0220-5AB0	36
420	100	420	185	102	26	92	10	72	174	16	517.5	489.0	18	8	13	0.32	0.32	2LC0220-5AA0	2LC0220-5AB0	38
										18	571.5	542.9	18	6	17	0.47		2LC0220-5AA0	2LC0220-5AB0	40

### Configurable variants <sup>1)</sup>

- ØD2                      Without finished bore  
                                  With finished bore

---

- Rubber version      WN  
                                  NN  
                                  SN  
                                  NX

<sup>1)</sup> To identify complete item numbers specifying the available finish boring options and – if necessary – further order options, please use our configurators on [flender.com](http://flender.com).

➤ For online configuration on [flender.com](http://flender.com), click on the item no.

Size	Dimensions in mm													Mass moment of inertia		Article no. <sup>1)</sup>		Weight <i>m</i> kg		
	D2 Keyway DIN 6885 max.	DA	ND2	NL2	short version		long version			Flange connection dimensions					<i>J</i> <sub>1</sub> kgm <sup>2</sup>	<i>J</i> <sub>2</sub> kgm <sup>2</sup>	Type			
					A	LG	A	S	LG	SAE size	DFA g7	DFK	FB	ZF			DFB		short version	long version
465	120	465	222	125	33	92	2	39	164	14	466.7	438.2	85	8	13	0.31	0.58	2LC0220-6AA0	2LC0220-6AB0	56
										16	517.5	489.0	27	8	13	0.41		2LC0220-6AA0	2LC0220-6AB0	57
										18	571.5	542.9	18	6	17	0.52		2LC0220-6AA0	2LC0220-6AB0	61
520	165	514	250	142	16	159	0	83	225	18	571.5	542.9	18	12	17	0.48	0.93	2LC0220-7AA0	2LC0220-7AB0	55
										21	673.1	641.4	18	12	17	0.95		2LC0220-7AA0	2LC0220-7AB0	60
560	200	560	320	140	30	130	2.5	83	223	18	571.5	542.9	35	12	17	0.85	1.2	2LC0220-8AA0	2LC0220-8AB0	69
										21	673.1	641.4	20	12	17	1.8		2LC0220-8AA0	2LC0220-8AB0	78
580	200	580	316	200	23	215	0	100	300	18	571.5	542.9	104	12	17	0.77	1.8	2LC0221-0AA0	2LC0221-0AB0	100
										21	673.1	641.4	26	12	17	1.2		2LC0221-0AA0	2LC0221-0AB0	105
680	220	682	380	210	24	232	0	102	312	21	673.1	641.4	85	12	17	4.1	5.3	2LC0221-1AA0	2LC0221-1AB0	205
										24	733.4	692.2	20	12	21	5.3		2LC0221-1AA0	2LC0221-1AB0	215

**Configurable variants <sup>1)</sup>**

- ØD2                      Without finished bore  
                                 With finished bore

---

- Rubber version      WN  
                                 NN  
                                 SN  
                                 NX

**Notes**

- The rubber disk element cannot be dismounted until the machines have been moved.
- Weight and mass moments of inertia apply to maximum bore diameters.

**Ordering example**

- ELPEX-S ESN coupling, size 520, WN rubber element version
- Bore ØD2 = 150H7 mm, with keyway to DIN 6885 and set screw, outer flange to SAE J620d size 21

Short version article no.: 2LC0220-7AA09-1JA0-Z M1W

Long version article no.: 2LC0220-7AB09-1JA0-Z M1W

<sup>1)</sup> To identify complete item numbers specifying the available finish boring options and – if necessary – further order options, please use our configurators on [fender.com](http://fender.com).

➤ For online configuration on [fender.com](http://fender.com), click on the item no.



# TYPE ESNR

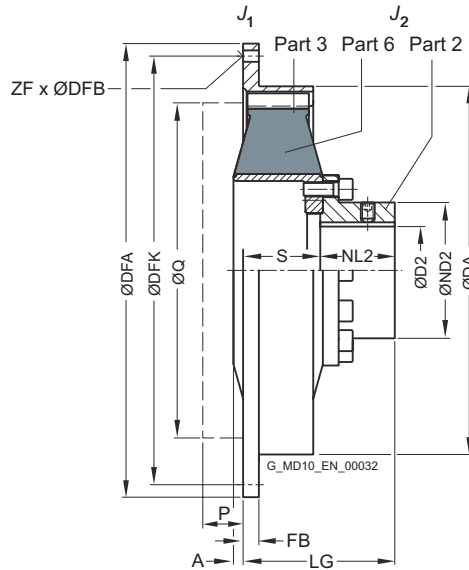

Size	Dimensions in mm										Flange connection dimensions					Mass moment of inertia		Article no. <sup>1)</sup>	Weight m kg
	D2 Keyway DIN 6885 max.	DA	ND2	NL2	S	A	P	Q	LG	SAE size	DFA	DFK	FB	ZF	DFB	J <sub>1</sub> kgm <sup>2</sup>	J <sub>2</sub> kgm <sup>2</sup>		
265	50	263	78	65	42	-	10	225	107	8	263.5	244.5	33	6	10.5	0.011	0.022	2LC0220-1AC0	5.0
										10	314.3	295.3	10	8		0.017		2LC0220-1AC0	5.3
										11.5	352.4	333.4	10	8		0.024		2LC0220-1AC0	5.6
290	50	290	78	65	59	2	15	276	124	10	314.3	295.3	16	8	10.5	0.026	0.026	2LC0220-2AC0	8.1
										11.5	352.4	333.4	16	8		0.036		2LC0220-2AC0	8.4
320	65	318	98	87	74	0	20	310	161	11.5	352.4	333.4	16	8	10.5	0.062	0.061	2LC0220-3AC0	13.5
										14	466.7	438.2	16	8		0.18		2LC0220-3AC0	16
360	85	353.5	123	88	77	9	28	314	165	11.5	352.4	333.4	54	8	10.5	0.065	0.13	2LC0220-4AC0	20
										14	466.7	438.2	15	8		0.18		2LC0220-4AC0	23
420	100	420	155	85	93	6	28	409	178	14	466.7	438.2	18	8	13	0.22	0.32	2LC0220-5AC0	31
										16	517.5	489.0	18	8		0.32		2LC0220-5AC0	32
										18	571.5	542.9	18	6		0.47		2LC0220-5AC0	35
465	130	465	190	119	88	-	15	409	207	14	466.7	438.2	85	8	13	0.31	0.58	2LC0220-6AC0	41
										16	517.5	489.0	27	8		0.41		2LC0220-6AC0	42
										18	571.5	542.9	18	6		0.52		2LC0220-6AC0	45

## Configurable variants <sup>1)</sup>

- ØD2 Without finished bore  
With finished bore
- Rubber version WN  
NN  
SN  
NX

<sup>1)</sup> To identify complete item numbers specifying the available finish boring options and – if necessary – further order options, please use our configurators on [flender.com](http://flender.com).

↗ For online configuration on [flender.com](http://flender.com), click on the item no.

Size	Dimensions in mm															Mass moment of inertia		Article no. <sup>1)</sup>	Weight <i>m</i> kg
	D2 Keyway DIN 6885 max.	DA	ND2	NL2	S	A	P	Q	LG	Flange connection dimensions						<i>J</i> <sub>1</sub> kgm <sup>2</sup>	<i>J</i> <sub>2</sub> kgm <sup>2</sup>		
										SAE size	DFA g7	DFK	FB	ZF	DFB				
520	150	514	227	162	85	-	10	498	247	18	571.5	542.9	18	12	17	0.48	0.93	2LC0220-7AC0	59
										21	673.1	641.4	18	12	17	0.95		2LC0220-7AC0	64
560	150	560	240	180	99	-	10	498	279	18	571.5	542.9	35	12	17	0.85	1.2	2LC0220-8AC0	75
										21	673.1	641.4	20	12	17	1.8		2LC0220-8AC0	85
580	160	580	240	200	102	-	10	498	302	18	571.5	542.9	104	12	17	0.77	1.8	2LC0221-0AC0	80
										21	673.1	641.4	26	12	17	1.2		2LC0221-0AC0	84
680	200	682	300	210	102	-	10	584	312	21	673.1	641.4	85	12	17	4.1	5.3	2LC0221-1AC0	155
										24	733.4	692.2	20	12	21	5.3		2LC0221-1AC0	165
											860.0	820.0	26	32	21	10.7		2LC0221-2AC0	330
770	260	780	390	255	134	-	10	750	389	-	920.0	880.0	27	32	21	15.4	12	2LC0221-2AC0	350
											995.0	950.0	27	32	21	20.5		2LC0221-2AC0	375

**Configurable variants<sup>1)</sup>**

- ØD2                      Without finished bore  
                                    With finished bore

---

- Rubber version      WN  
                                    NN  
                                    SN  
                                    NX

**Notes**

- Weight and mass moments of inertia apply to maximum bore diameters.
- P, Q = required space for radial dismounting of the rubber disk element.

**Ordering example**

- ELPEX-S ESNR coupling, size 320, WN rubber element version
- Bore ØD2 = 50H7 mm, with keyway to DIN 6885 and set screw, outer flange to SAE J620d size 14

Article no.: 2LC0220-3AC09-1FA0-Z M1C

<sup>1)</sup> To identify complete item numbers specifying the available finish boring options and – if necessary – further order options, please use our configurators on [fender.com](http://fender.com).  
 ↗ For online configuration on [fender.com](http://fender.com), click on the item no.

# TYPE ESD

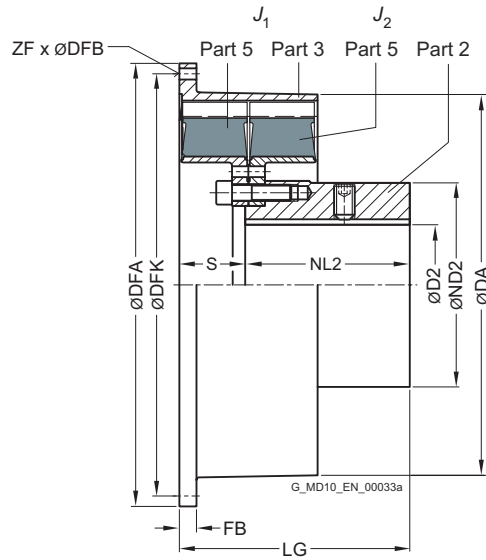

Size	Dimensions in mm						Flange connection dimensions						Mass moment of inertia		Article no. <sup>1)</sup>	Weight <i>m</i> kg
	D2 Keyway DIN 6885 max.	DA	ND2	NL2	S	LG	SAE size	DFA	DFK	FB	ZF	DFB	<i>J</i> <sub>1</sub> kgm <sup>2</sup>	<i>J</i> <sub>2</sub> kgm <sup>2</sup>		
520	165	525	250	174	81	255	18	571.5	542.9	25	12	17	1	1.6	2LC0220-7AD0	85
							21	673.1	641.4	18	12	17	1.5			90
560	170	560	316	210	60	270	18	571.5	542.9	35	12	17	1.7	2.8	2LC0220-8AD0	140
							21	673.1	641.4	25	12	17	2.6			150
580	200	585	310	250	100	350	21	673.1	641.4	26	12	17	2	3.8	2LC0221-0AD0	170
							24	733.4	692.2	26	12	21	2.6			175
680	220	682	380	250	17	267	21	673.1	641.4	85	12	17	8.2	7	2LC0221-1AD0	265
							24	733.4	692.2	20	12	21	9.4			275

### Configurable variants <sup>1)</sup>

- ØD2 Without finished bore  
With finished bore
- Rubber version WN  
NN  
SN  
NX

### Notes

- The rubber disk element cannot be dismantled until the machines have been moved.
- Weight and mass moments of inertia apply to maximum bore diameters.

### Ordering example

- ELPEX-S ESD coupling, size 680, WN rubber element version
- Bore ØD2 = 180H7 mm, with keyway to DIN 6885 and set screw, outer flange to SAE J620d size 24

Article no.: 2LC0221-1AD09-1KA0-Z M2B

<sup>1)</sup> To identify complete item numbers specifying the available finish boring options and – if necessary – further order options, please use our configurators on [flender.com](http://flender.com).

↗ For online configuration on [flender.com](http://flender.com), click on the item no.

# TYPE ESDR

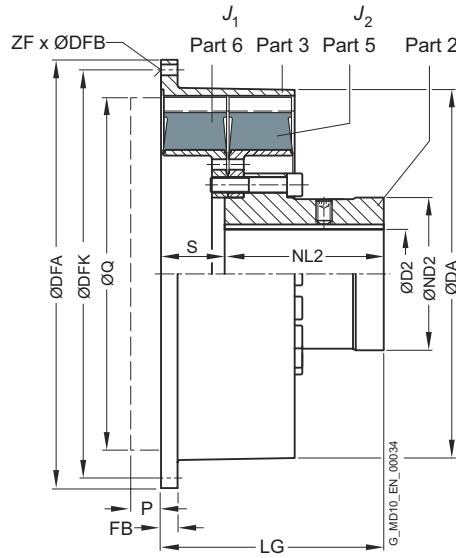

Size	Dimensions in mm								Flange connection dimensions					Mass moment of inertia		Article no. <sup>1)</sup>	Weight <i>m</i> kg	
	D2 Keyway DIN 6885 max.	DA	ND2	NL2	S	P	Q	LG	SAE size	DFA	DFK	FB	ZF	DFB	<i>J</i> <sub>1</sub> kgm <sup>2</sup>			<i>J</i> <sub>2</sub> kgm <sup>2</sup>
520	150	525	227	226	83	10	498	309	18	571.5	542.9	25	12	17	1	1.8	2LC0220-7AE0	105
									21	673.1	641.4	18	12	17	1.5		2LC0220-7AE0	110
560	160	560	240	240	100	10	498	340	18	571.5	542.9	35	12	17	1.7	2.5	2LC0220-8AE0	135
									21	673.1	641.4	25	12	17	2.6		2LC0220-8AE0	140
580	160	585	240	250	100	10	560	350	21	673.1	641.4	26	12	17	2	3.2	2LC0221-0AE0	145
									24	733.4	692.2	26	12	21	2.6		2LC0221-0AE0	150
680	200	682	300	250	102	10	584	352	21	673.1	641.4	85	12	17	8.2	6.5	2LC0221-1AE0	260
									24	733.4	692.2	20	12	21	9.4		2LC0221-1AE0	270
770	260	780	390	300	200	10	750	500	-	860.0	820.0	19	32	-	22.3	20	2LC0221-2AE0	540
									-	920.0	880.0	27	32	21	26		2LC0221-2AE0	555
									-	995.0	950.0	27	32	-	31		2LC0221-2AE0	600

### Configurable variants<sup>1)</sup>

- ØD2 Without finished bore  
With finished bore
- Rubber version WN  
NN  
SN  
NX

### Notes

- Weight and mass moments of inertia apply to maximum bore diameters.
- P, Q = required space for radial dismounting of the rubber disk element.

### Ordering example

- ELPEX-S ESDR coupling, size 560, WN rubber element version
- Bore ØD2 = 120H7 mm, with keyway to DIN 6885 and set screw, outer flange to SAE J620d size 21

Article no.: 2LC0220-8AE09-1JA0-Z M1S

<sup>1)</sup> To identify complete item numbers specifying the available finish boring options and – if necessary – further order options, please use our configurators on [flender.com](http://flender.com).

↗ For online configuration on [flender.com](http://flender.com), click on the item no.

# TYPE ESNW

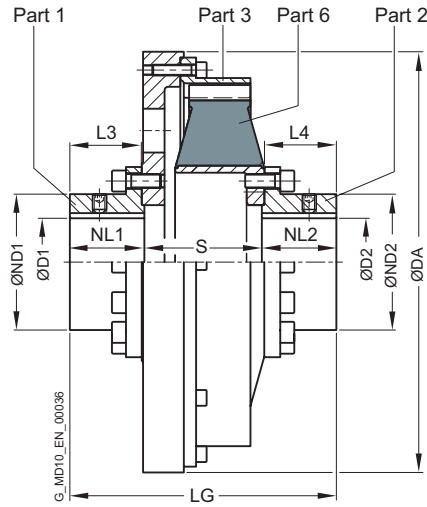

Size	Dimensions in mm								Mass moment of inertia		Article no. <sup>1)</sup>	Weight <i>m</i> kg
	D1/D2 Keyway DIN 6885 max.	DA	ND1/ND2	NL1/NL2	L3	L4	S	LG	<i>J</i> <sub>1</sub> kgm <sup>2</sup>	<i>J</i> <sub>2</sub> kgm <sup>2</sup>		
265	50	275	78	65	62	66	68	198	0.11	0.017	2LC0220-1AG	15
290	50	325	78	65	62	68	89	219	0.21	0.028	2LC0220-2AG	22
320	65	365	98	87	84	92	105	279	0.37	0.042	2LC0220-3AG	32
360	85	365	123	88	85	96	123	299	0.45	0.11	2LC0220-4AG	43
420	100	480	155	85	82	94	134	304	1.5	0.3	2LC0220-5AG	75
465	130	480	190	119	116	119	125	363	1.6	0.54	2LC0220-6AG	89
520	150	585	227	162	159	161	123	447	4	0.94	2LC0220-7AG	155
560	150	585	240	180	174	174	132	492	4.1	1.2	2LC0220-8AG	160
580	160	685	240	200	195	198	145	545	5.5	1.6	2LC0221-0AG	185
680	200	685	300	210	205	201	150	570	12	3.6	2LC0221-1AG	315
770	260	870	390	255	250	253	180	690	27.2	12	2LC0221-2AG	500

## Configurable variants <sup>1)</sup>

• ØD1	Without finished bore With finished bore
• ØD2	Without finished bore With finished bore
• Rubber version	WN NN SN NX

## Notes

- Weight and mass moments of inertia apply to maximum bore diameters.

## Ordering example

- ELPEX-S ESNW coupling, size 520, WN rubber element version
- Bore ØD1 140H7 mm, keyway to DIN 6885 and set screw
- Bore ØD2 120H7 mm, keyway to DIN 6885 and set screw

Article no.: 2LC0220-7AG99-1AA0-Z L1V+M1S

<sup>1)</sup> To identify complete item numbers specifying the available finish boring options and – if necessary – further order options, please use our configurators on [flender.com](http://flender.com).

↗ For online configuration on [flender.com](http://flender.com), click on the item no.

# TYPE ESDW

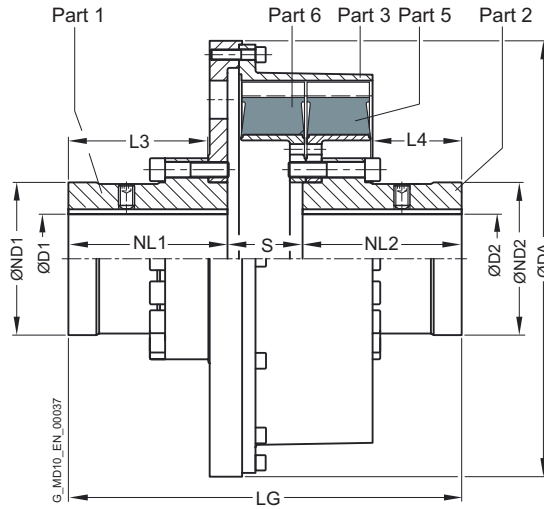

Size	Dimensions in mm								Mass moment of inertia		Article no. <sup>1)</sup>	Weight m kg
	D1/D2 Keyway DIN 6885 max.	DA	ND1/ND2	NL1/NL2	L3	L4	S	LG	J <sub>1</sub> kgm <sup>2</sup>	J <sub>2</sub> kgm <sup>2</sup>		
520	150	585	227	226	201	135	100	552	4.7	1.8	2LC0220-7AH	215
560	160	585	240	240	215	133	114	594	5.4	2.5	2LC0220-8AH	250
580	160	685	240	250	220	140	120	620	10.1	3.2	2LC0221-0AH	300
680	200	685	300	250	218	134	125	625	14.5	6.5	2LC0221-1AH	440
770	260	870	390	300	265	238	220	820	40	20	2LC0221-2AH	720

## Configurable variants <sup>1)</sup>

• ØD1	Without finished bore With finished bore
• ØD2	Without finished bore With finished bore
• Rubber version	WN NN SN NX

## Notes

- Weight and mass moments of inertia apply to maximum bore diameters.

## Ordering example

- ELPEX-S ESDW coupling, size 520, WN rubber element version
- Bore ØD1 140H7 mm, keyway to DIN 6885 and set screw
- Bore ØD2 120H7 mm, keyway to DIN 6885 and set screw

Article no.: 2LC0220-7AH99-1AA0-Z L1V+M1S

<sup>1)</sup> To identify complete item numbers specifying the available finish boring options and – if necessary – further order options, please use our configurators on [flender.com](http://flender.com).

➤ For online configuration on [flender.com](http://flender.com), click on the item no.

# TYPE EST

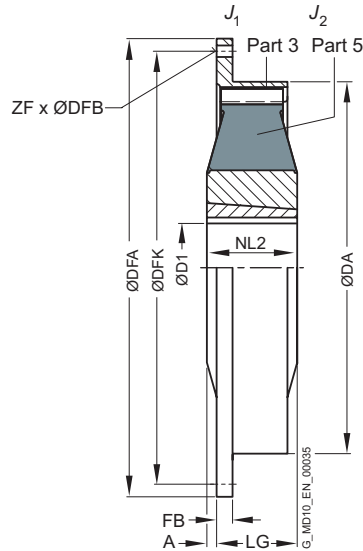

Size	Taper Clamping Bush Size	Dimensions in mm						Flange connection dimensions					Mass moment of inertia		Article no. <sup>1)</sup>	Weight <i>m</i> kg		
		D1 Keyway DIN 6885 min.	max.	DA	NL2	A	LG	SAE size	DFA	DFK	FB	ZF	DFB	<i>J</i> <sub>1</sub> kgm <sup>2</sup>			<i>J</i> <sub>2</sub> kgm <sup>2</sup>	
220	2012	14	50	222	32	0	43	52	6.5	215.9	200.0	6	6	8.5	0.008	0.008	2LC0220-0AF0	3.6
								7.5	241.3	222.3	33	8	8.5	0.008	2LC0220-0AF0		3.5	
								8	263.5	244.5	8	6	10.5	0.011	2LC0220-0AF0		3.7	
								10	314.3	295.3	8	8	10.5	0.020	2LC0220-0AF0		4.2	
265	2517	16	60	263	45	3	42	8	263.5	244.5	33	6	0.011	0.019	2LC0220-1AF0	5.9		
								10	314.3	295.3	10	8	10.5		0.017	2LC0220-1AF0	6.2	
								11.5	352.4	333.4	10	8	0.024		2LC0220-1AF0	6.5		
290	2517	16	60	290	64	6	58	10	314.3	295.3	16	8	0.026	0.026	2LC0220-2AF0	8.5		
								11.5	352.4	333.4	16	8	10.5		0.036	2LC0220-2AF0	8.8	
320	3030	35	75	318	76	2	73	11.5	352.4	333.4	16	8	0.062	0.06	2LC0220-3AF0	14		
								14	466.7	438.2	16	8	13		0.18	2LC0220-3AF0	17	
360	3535	35	90	353.5	89	13	76	11.5	352.4	333.4	54	8	0.065	0.13	2LC0220-4AF0	21		
								14	466.7	438.2	15	8	13		0.18	2LC0220-4AF0	24	
								14	466.7	438.2	18	8	13		0.22	2LC0220-5AF0	37	
420	4040	40	100	420	102	10	92	16	517.5	489.0	18	8	0.32	0.33	2LC0220-5AF0	38		
								18	571.5	542.9	18	6	17		0.47	2LC0220-5AF0	41	
								14	466.7	438.2	85	8	13		0.31	2LC0220-6AF0	63	
465	4545	55	110	465	115	28	87	16	517.5	489.0	27	8	0.41	0.76	2LC0220-6AF0	64		
								18	571.5	542.9	18	6	17		0.52	2LC0220-6AF0	68	

### Configurable variants <sup>1)</sup>

- ØD1 Without finished bore  
With finished bore
- Rubber version WN  
NN  
SN  
NX

### Notes

- The rubber disk element cannot be dismantled until the machines have been moved.
- Weight and mass moments of inertia apply to maximum bore diameters.

### Ordering example

- ELPEX-S EST coupling, size 265, WN rubber element version, with Taper clamping bush size 2517
- Bore ØD2 = 30 mm, outer flange to SAE J620d size 10

Article no.: 2LC0220-1AF99-1DA0-Z M05

<sup>1)</sup> To identify complete item numbers specifying the available finish boring options and – if necessary – further order options, please use our configurators on [flender.com](http://flender.com).

↗ For online configuration on [flender.com](http://flender.com), click on the item no.

# SPARE AND WEAR PARTS

## Rubber disk elements

Size	➤ Article No. set of rubber disk elements for a coupling					
	Coupling type EST		ESN	ESNR, ESNW	ESD	ESDR, ESDW
	without Taper clamping bush	with Taper clamping bush				
<b>WN rubber version</b>						
220	2LC0220-0XL10-1AA0	2LC0220-0XL90-1AA0	2LC0220-0XJ00-1AA0			
265	2LC0220-1XL10-1AA0	2LC0220-1XL90-1AA0	2LC0220-1XJ00-1AA0	2LC0220-1XM00-1AA0		
290	2LC0220-2XL10-1AA0	2LC0220-2XL90-1AA0	2LC0220-2XJ00-1AA0	2LC0220-2XM00-1AA0		
320	2LC0220-3XL10-1AA0	2LC0220-3XL90-1AA0	2LC0220-3XJ00-1AA0	2LC0220-3XM00-1AA0		
360	2LC0220-4XL10-1AA0	2LC0220-4XL90-1AA0	2LC0220-4XJ00-1AA0	2LC0220-4XM00-1AA0		
420	2LC0220-5XL10-1AA0	2LC0220-5XL90-1AA0	2LC0220-5XJ00-1AA0	2LC0220-5XM00-1AA0		
465	2LC0220-6XL10-1AA0	2LC0220-6XL90-1AA0	2LC0220-6XJ00-1AA0	2LC0220-6XM00-1AA0		
520			2LC0220-7XJ00-1AA0	2LC0220-7XM00-1AA0	2LC0220-7XK00-1AA0	2LC0220-7XN00-1AA0
560			2LC0220-8XJ00-1AA0	2LC0220-8XM00-1AA0	2LC0220-8XK00-1AA0	2LC0220-8XN00-1AA0
580			2LC0221-0XJ00-1AA0	2LC0221-0XM00-1AA0	2LC0221-0XK00-1AA0	2LC0221-0XN00-1AA0
680			2LC0221-1XJ00-1AA0	2LC0221-1XM00-1AA0	2LC0221-1XK00-1AA0	2LC0221-1XN00-1AA0
770				2LC0221-2XM00-1AA0		2LC0221-2XN00-1AA0
<b>NN rubber version</b>						
220	2LC0220-0XL10-2AA0	2LC0220-0XL90-2AA0	2LC0220-0XJ00-2AA0			
265	2LC0220-1XL10-2AA0	2LC0220-1XL90-2AA0	2LC0220-1XJ00-2AA0	2LC0220-1XM00-2AA0		
290	2LC0220-2XL10-2AA0	2LC0220-2XL90-2AA0	2LC0220-2XJ00-2AA0	2LC0220-2XM00-2AA0		
320	2LC0220-3XL10-2AA0	2LC0220-3XL90-2AA0	2LC0220-3XJ00-2AA0	2LC0220-3XM00-2AA0		
360	2LC0220-4XL10-2AA0	2LC0220-4XL90-2AA0	2LC0220-4XJ00-2AA0	2LC0220-4XM00-2AA0		
420	2LC0220-5XL10-2AA0	2LC0220-5XL90-2AA0	2LC0220-5XJ00-2AA0	2LC0220-5XM00-2AA0		
465	2LC0220-6XL10-2AA0	2LC0220-6XL90-2AA0	2LC0220-6XJ00-2AA0	2LC0220-6XM00-2AA0		
520			2LC0220-7XJ00-2AA0	2LC0220-7XM00-2AA0	2LC0220-7XK00-2AA0	2LC0220-7XN00-2AA0
560			2LC0220-8XJ00-2AA0	2LC0220-8XM00-2AA0	2LC0220-8XK00-2AA0	2LC0220-8XN00-2AA0
580			2LC0221-0XJ00-2AA0	2LC0221-0XM00-2AA0	2LC0221-0XK00-2AA0	2LC0221-0XN00-2AA0
680			2LC0221-1XJ00-2AA0	2LC0221-1XM00-2AA0	2LC0221-1XK00-2AA0	2LC0221-1XN00-2AA0
770				2LC0221-2XM00-2AA0		2LC0221-2XN00-2AA0
<b>SN rubber version</b>						
220	2LC0220-0XL10-3AA0	2LC0220-0XL90-3AA0	2LC0220-0XJ00-3AA0			
265	2LC0220-1XL10-3AA0	2LC0220-1XL90-3AA0	2LC0220-1XJ00-3AA0	2LC0220-1XM00-3AA0		
290	2LC0220-2XL10-3AA0	2LC0220-2XL90-3AA0	2LC0220-2XJ00-3AA0	2LC0220-2XM00-3AA0		
320	2LC0220-3XL10-3AA0	2LC0220-3XL90-3AA0	2LC0220-3XJ00-3AA0	2LC0220-3XM00-3AA0		
360	2LC0220-4XL10-3AA0	2LC0220-4XL90-3AA0	2LC0220-4XJ00-3AA0	2LC0220-4XM00-3AA0		
420	2LC0220-5XL10-3AA0	2LC0220-5XL90-3AA0	2LC0220-5XJ00-3AA0	2LC0220-5XM00-3AA0		
465	2LC0220-6XL10-3AA0	2LC0220-6XL90-3AA0	2LC0220-6XJ00-3AA0	2LC0220-6XM00-3AA0		
520			2LC0220-7XJ00-3AA0	2LC0220-7XM00-3AA0	2LC0220-7XK00-3AA0	2LC0220-7XN00-3AA0
560			2LC0220-8XJ00-3AA0	2LC0220-8XM00-3AA0	2LC0220-8XK00-3AA0	2LC0220-8XN00-3AA0
580			2LC0221-0XJ00-3AA0	2LC0221-0XM00-3AA0	2LC0221-0XK00-3AA0	2LC0221-0XN00-3AA0
680			2LC0221-1XJ00-3AA0	2LC0221-1XM00-3AA0	2LC0221-1XK00-3AA0	2LC0221-1XN00-3AA0
770				2LC0221-2XM00-3AA0		2LC0221-2XN00-3AA0
<b>NX rubber version</b>						
220	2LC0220-0XL10-4AA0	2LC0220-0XL90-4AA0	2LC0220-0XJ00-4AA0			
265	2LC0220-1XL10-4AA0	2LC0220-1XL90-4AA0	2LC0220-1XJ00-4AA0	2LC0220-1XM00-4AA0		
290	2LC0220-2XL10-4AA0	2LC0220-2XL90-4AA0	2LC0220-2XJ00-4AA0	2LC0220-2XM00-4AA0		
320	2LC0220-3XL10-4AA0	2LC0220-3XL90-4AA0	2LC0220-3XJ00-4AA0	2LC0220-3XM00-4AA0		
360	2LC0220-4XL10-4AA0	2LC0220-4XL90-4AA0	2LC0220-4XJ00-4AA0	2LC0220-4XM00-4AA0		
420	2LC0220-5XL10-4AA0	2LC0220-5XL90-4AA0	2LC0220-5XJ00-4AA0	2LC0220-5XM00-4AA0		
465	2LC0220-6XL10-4AA0	2LC0220-6XL90-4AA0	2LC0220-6XJ00-4AA0	2LC0220-6XM00-4AA0		
520			2LC0220-7XJ00-4AA0	2LC0220-7XM00-4AA0	2LC0220-7XK00-4AA0	2LC0220-7XN00-4AA0
560			2LC0220-8XJ00-4AA0	2LC0220-8XM00-4AA0	2LC0220-8XK00-4AA0	2LC0220-8XN00-4AA0
580			2LC0221-0XJ00-4AA0	2LC0221-0XM00-4AA0	2LC0221-0XK00-4AA0	2LC0221-0XN00-4AA0
680			2LC0221-1XJ00-4AA0	2LC0221-1XM00-4AA0	2LC0221-1XK00-4AA0	2LC0221-1XN00-4AA0
770				2LC0221-2XM00-4AA0		2LC0221-2XN00-4AA0

### Notes

- The ELPEX-S coupling rubber disk elements are wear parts. The service life depends on the operating conditions.





FLENDER COUPLINGS  
CATALOG **FLE 10.3**  
EDITION 2023 EN



WE  
**MOVE** the  
WORLD

---

**Flender GmbH**

Alfred-Flender-Straße 77  
46395 Bocholt  
Germany

Article no.: FLEX-C10003-00-7600

**ABM TECNA**

Rue des sources 5  
6220 FLEURUS  
Belgium

+32 71 85 85 00  
sales@abm-tecna.be  
www.abm-tecna.be

Subject to changes and errors.

The information given in this product catalog includes descriptions and performance features that in specific applications do not always apply in the form described or may change through further-development of the products. The desired performance features are binding only if they are expressly agreed on conclusion of contract. Subject to availability for delivery and to technical changes.